



Peak pulse voltage ( $T_j=25^{\circ}\text{C}$ ; non-repetitive, off-state; FIG.7)	$V_{PP}$	3.5	kV
--	----------	-----	----

**ELECTRICAL CHARACTERISTICS** ( $T_j=25^{\circ}\text{C}$  unless otherwise specified)

Symbol	Test Condition	Quadrant	Value		Unit
$I_{GT}$	$V_D=12\text{V } R_L=33\Omega$	ALL	MAX.	5	mA
$V_{GT}$		ALL	MAX.	1.3	V
$V_{GD}$	$V_D=V_{DRM} T_j=125^{\circ}\text{C}$ $R_L=3.3\text{K}\Omega$	ALL	MIN.	0.2	V
$I_L$	$I_G=1.2I_{GT}$	I -III-IV	MAX.	5	mA
		II		10	
$I_H$	$I_T=50\text{mA}$		MAX.	5	mA
dV/dt	$V_D=400\text{V}$ Gate Open $T_j=110^{\circ}\text{C}$		MIN.	30	V/ $\mu\text{s}$
(dV/dt) <sub>c</sub>	(dI/dt) <sub>c</sub> =0.44A/ms, $T_j=110^{\circ}\text{C}$		MIN.	1	V/ $\mu\text{s}$
$t_{on}$	$I_G=10\text{mA } I_A=200\text{mA } I_R=20\text{mA}$ $T_j=25^{\circ}\text{C}$		TYP.	2	$\mu\text{s}$
$t_{off}$				20	

**STATIC CHARACTERISTICS**

Symbol	Parameter		Value(MAX.)	Unit
$V_{TM}$	$I_{TM}=1.4\text{A } t_p=380\mu\text{s}$	$T_j=25^{\circ}\text{C}$	1.45	V
$V_{TO}$	Threshold voltage	$T_j=125^{\circ}\text{C}$	0.96	V
$R_D$	Dynamic resistance	$T_j=125^{\circ}\text{C}$	225	m $\Omega$
$I_{DRM}$	$V_D=V_{DRM} V_R=V_{RRM}$	$T_j=25^{\circ}\text{C}$	5	$\mu\text{A}$
$I_{RRM}$		$T_j=125^{\circ}\text{C}$	0.2	mA

**THERMAL RESISTANCES**

Symbol	Parameter	Value	Unit
$R_{th(j-c)}$	junction to case (AC)	60	$^{\circ}\text{C/W}$
$R_{th(j-a)}$	junction to ambient (AC)	150	$^{\circ}\text{C/W}$

**ORDERING INFORMATION**

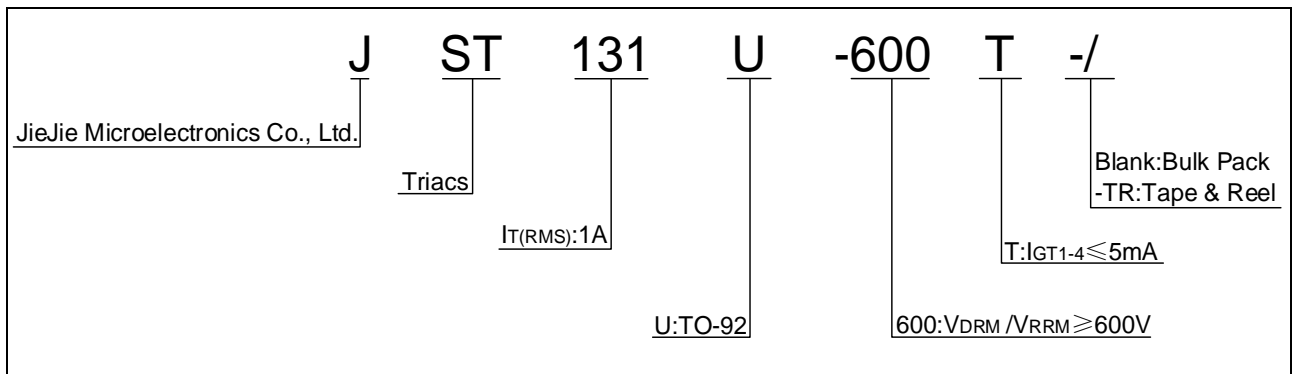

**MARKING**

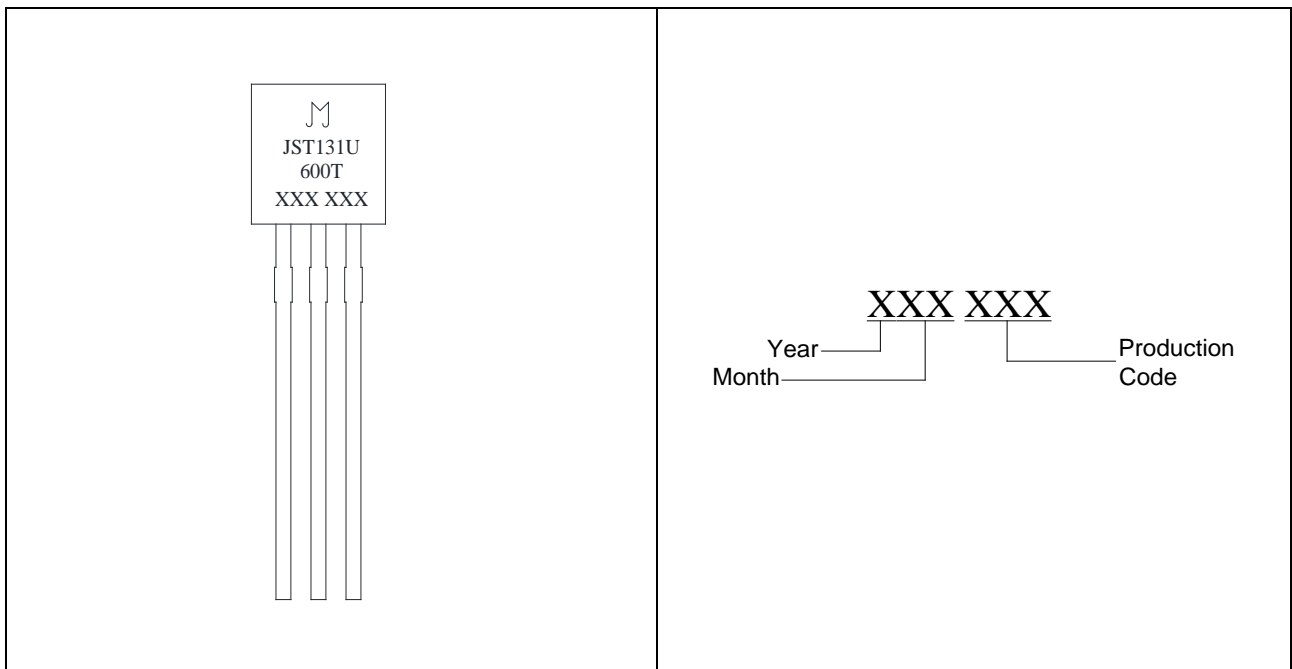

**FIG.1** Maximum power dissipation versus RMS on-state current

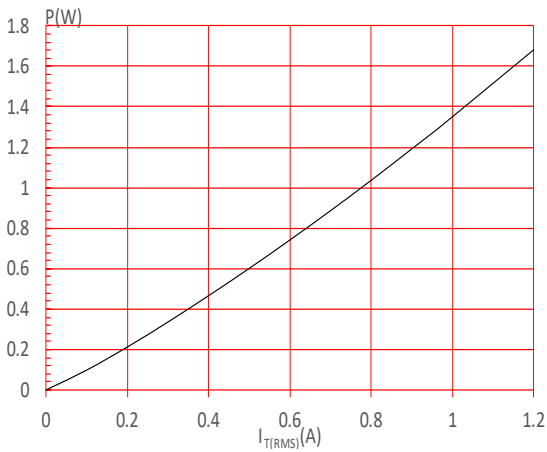

**FIG.3:** Surge peak on-state current versus number of cycles

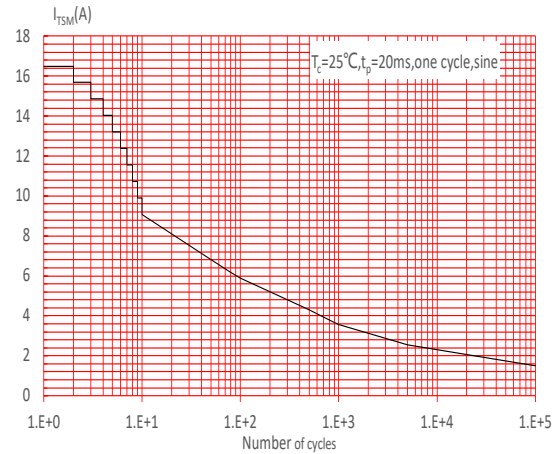

**FIG.5:** Non-repetitive surge peak on-state current for a sinusoidal pulse with width  $t_p < 20\text{ms}$ , and corresponding value of  $I^2t$  ( I - II :  $di/dt < 30\text{A}/\mu\text{s}$ ; III-IV :  $di/dt < 20\text{A}/\mu\text{s}$ )

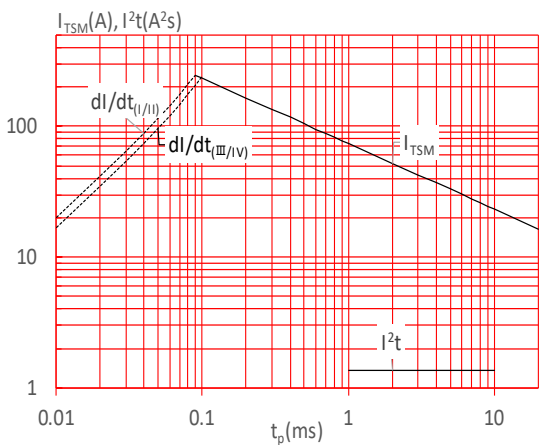

**FIG.2:** RMS on-state current versus case temperature

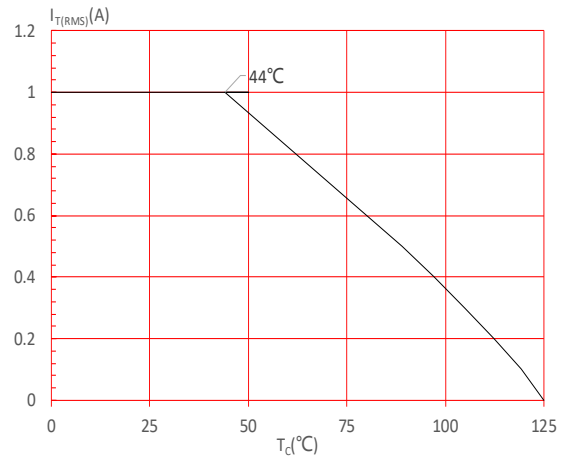

**FIG.4:** On-state characteristics

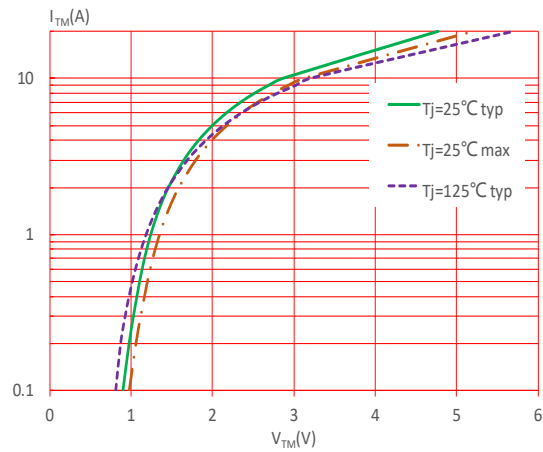

**FIG.6:** Relative variations of gate trigger current, holding current and latching current versus junction temperature

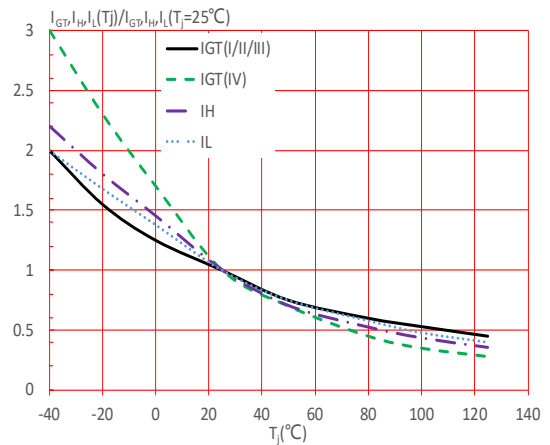
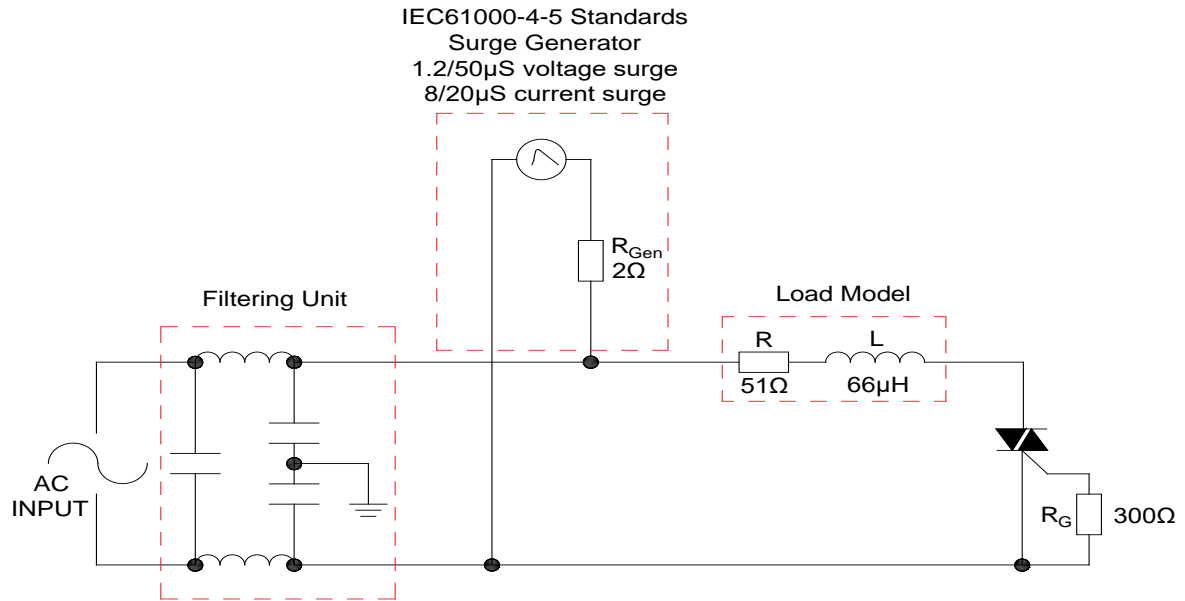

FIG.7: Test circuit for inductive and resistive loads to IEC-61000-4-5 standards



## SHAPING AND SOLDERING PARAMETERS

Refer to 《Instructions for installation of plastic-sealed in-line power devices》 released by JieJie

**ORDERING INFORMATION**

Order code	Voltage $V_{DRM}/V_{RRM}$ (V)	IGT(mA)	Package	Base qty. (pcs)	Delivery mode
		I -II-III-IV			
JST131U-600T	600	5	TO-92	1,000	Bulk Pack
JST131U-600T-TR				2,000	Tape & Reel

**Document Revision History**

Date	Revision	Changes
Apr.14, 2023	A.1.0	Last updated

PACKAGE MECHANICAL DATA

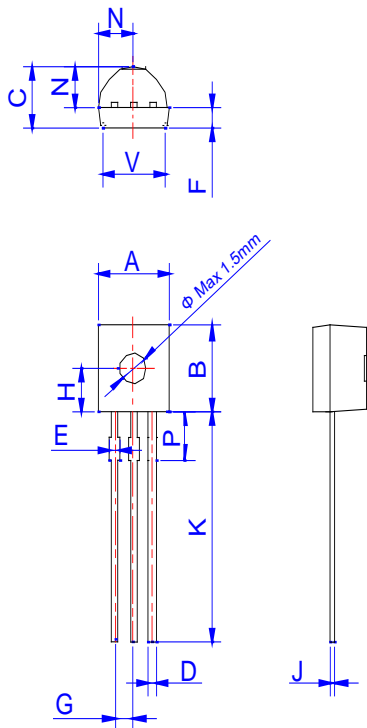

Ref.	Dimensions					
	Millimeters			Inches		
	Min.	Typ.	Max.	Min.	Typ.	Max.
A	4.45		5.20	0.175		0.205
B	4.32		5.33	0.170		0.210
C	3.18		4.19	0.125		0.165
D	0.407		0.533	0.016		0.021
E	0.50		0.70	0.020		0.028
F	1.10		1.30			0.051
G	1.10		1.40	0.043		0.055
H	2.20		2.40	0.087		0.094
J	0.36		0.50	0.014		0.020
K	12.70		15.0	0.500		0.591
N	2.04		2.66	0.080		0.105
P	1.80		2.30	0.071		0.091
V	4.10		4.50	0.161		0.177

**DELIVERY MODE**

PACKAGE	OUTLINE	BAG (PCS)	INNER BOX (PCS)	CARTON BOX (PCS)
TO-92	Bulk Pack	1,000	10,000	50,000

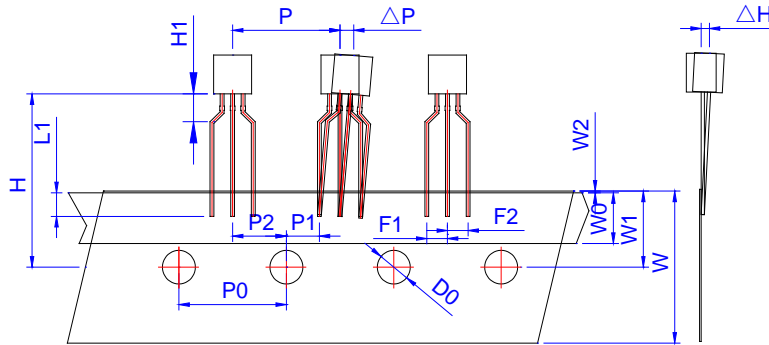

Ref.	Dimensions					
	Millimeters			Inches		
	Min.	Typ.	Max.	Min.	Typ.	Max.
P	12.40	12.70	13.00	0.488	0.500	0.512
P0	12.40	12.70	13.00	0.488	0.500	0.512
P1	3.55	3.85	4.15	0.140	0.152	0.163
P2	5.95	6.35	6.75	0.233	0.250	0.265
ΔP	-1.0	0	1.0	-0.039	0	0.039
F1、F2	2.30	2.50	2.70	0.090	0.098	0.106
F1-F2	-0.1	0	0.1	-0.004	0	0.004
W	17.50	18.00	19.00	0.689	0.709	0.748
W0	5.50	6.00	6.50	0.217	0.236	0.256
W1	8.50	9.00	9.50	0.335	0.354	0.374
W2			1.0			0.039
D0	3.80	4.0	4.20	0.150	0.157	0.165
ΔH	-1.0	0	1.0	-0.039	0	0.039
L1	2.5			0.098		
H	18.0	19.0	20.0	0.709	0.748	0.787
H1			2.70			0.106

PACKAGE	OUTLINE	REEL (PCS)	INNER BOX (PCS)	CARTON BOX (PCS)
TO-92	Tape & Reel	/	2,000	20,000



Information furnished in this document is believed to be accurate and reliable. However, Jiangsu JieJie Microelectronics Co., Ltd. assumes no responsibility for the consequences of use without consideration for such information nor use beyond it. Information mentioned in this document is subject to change without notice, apart from that when an agreement is signed, Jiangsu JieJie complies with the agreement.

Products and information provided in this document have no infringement of patents. Jiangsu JieJie assumes no responsibility for any infringement of other rights of third parties which may result from the use of such products and information. This document supersedes and replaces all information previously supplied.



is a registered trademark of Jiangsu JieJie Microelectronics Co., Ltd.

Copyright ©2023 Jiangsu JieJie Microelectronics Co., Ltd. Printed All rights reserved.