



# 100V 14.5mΩ N-Ch Power MOSFET

## Features

- Low ON-resistance,  $R_{DS(ON)}$
- Low Gate Charge,  $Q_g$
- 100% UIS and  $R_g$  Tested
- Pb-free Lead Plating
- Halogen-free and RoHS-compliant
- AEC-Q101 Qualified for Automotive Applications

## Product Summary

Parameter	Value	Unit
$V_{DS}$	100	V
$V_{GS(th\_Typ)}$	1.8	V
$I_D (@ V_{GS} = 10V)^{(1)}$	47	A
$R_{DS(ON\_Typ)} (@ V_{GS} = 10V)$	15.0	mΩ
$R_{DS(ON\_Typ)} (@ V_{GS} = 4.5V)$	18.7	mΩ

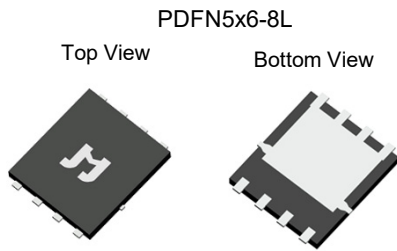

Top View  
Pin Configuration

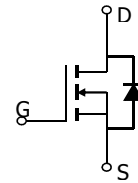
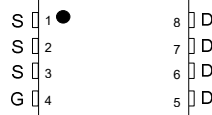

## Ordering Information

Device	Package	# of Pins	Marking	MSL	$T_J$ (°C)	Media	Quantity (pcs)
JMSL1018AGQ-13	PDFN5x6-8L	8	SL1018AQ	1	-55 to 175	13-inch Reel	5000

## Absolute Maximum Ratings (@ $T_A = 25^\circ\text{C}$ unless otherwise specified)

Parameter	Symbol	Value	Unit
Drain-to-Source Voltage	$V_{DS}$	100	V
Gate-to-Source Voltage	$V_{GS}$	±20	V
Continuous Drain Current <sup>(1)</sup>	$I_D$	$T_C = 25^\circ\text{C}$	47
		$T_C = 100^\circ\text{C}$	33
Pulsed Drain Current <sup>(2)</sup>	$I_{DM}$	186	A
Avalanche Current <sup>(3)</sup>	$I_{AS}$	24	A
Avalanche Energy <sup>(3)</sup>	$E_{AS}$	29	mJ
Power Dissipation <sup>(4)</sup>	$P_D$	$T_C = 25^\circ\text{C}$	88
		$T_C = 100^\circ\text{C}$	44
Junction & Storage Temperature Range	$T_J, T_{STG}$	-55 to 175	°C

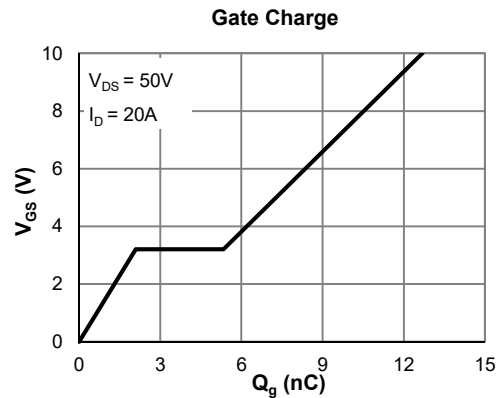
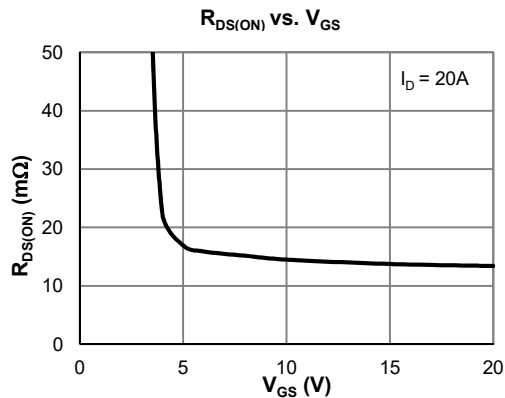

**Electrical Characteristics** (@  $T_j = 25^\circ\text{C}$  unless otherwise specified)

Parameter	Symbol	Conditions	Min.	Typ.	Max.	Unit
<b>STATIC PARAMETERS</b>						
Drain-Source Breakdown Voltage	$V_{(BR)DSS}$	$I_D = 250\mu\text{A}, V_{GS} = 0\text{V}$	100			V
Zero Gate Voltage Drain Current	$I_{DSS}$	$V_{DS} = 80\text{V}, V_{GS} = 0\text{V}$ $T_j = 55^\circ\text{C}$			1.0 5.0	$\mu\text{A}$
Gate-Body Leakage Current	$I_{GSS}$	$V_{DS} = 0\text{V}, V_{GS} = \pm 20\text{V}$			$\pm 100$	nA
Gate Threshold Voltage	$V_{GS(th)}$	$V_{DS} = V_{GS}, I_D = 250\mu\text{A}$	1.2	1.8	2.5	V
Static Drain-Source ON-Resistance	$R_{DS(ON)}$	$V_{GS} = 10\text{V}, I_D = 20\text{A}$		15.0	18.7	$\text{m}\Omega$
Static Drain-Source ON-Resistance	$R_{DS(ON)}$	$V_{GS} = 4.5\text{V}, I_D = 15\text{A}$		18.7	24.4	$\text{m}\Omega$
Forward Transconductance	$g_{FS}$	$V_{DS} = 5\text{V}, I_D = 20\text{A}$		49		S
Diode Forward Voltage	$V_{SD}$	$I_S = 1\text{A}, V_{GS} = 0\text{V}$		0.71	1.0	V
Diode Continuous Current	$I_S$	$T_C = 25^\circ\text{C}$			88	A
<b>DYNAMIC PARAMETERS</b> <sup>(5)</sup>						
Input Capacitance	$C_{iss}$	$V_{GS} = 0\text{V}, V_{DS} = 50\text{V}, f = 1\text{MHz}$		769		pF
Output Capacitance	$C_{oss}$			171		pF
Reverse Transfer Capacitance	$C_{rss}$			5.1		pF
Gate Resistance	$R_g$	$V_{GS} = 0\text{V}, V_{DS} = 0\text{V}, f = 1\text{MHz}$		1.9		$\Omega$
<b>SWITCHING PARAMETERS</b> <sup>(5)</sup>						
Total Gate Charge (@ $V_{GS} = 10\text{V}$ )	$Q_g$	$V_{GS} = 0 \text{ to } 10\text{V}$ $V_{DS} = 50\text{V}, I_D = 20\text{A}$		12.7		nC
Total Gate Charge (@ $V_{GS} = 4.5\text{V}$ )	$Q_g$			6.7		nC
Gate Source Charge	$Q_{gs}$			2.1		nC
Gate Drain Charge	$Q_{gd}$			3.3		nC
Turn-On DelayTime	$t_{D(on)}$	$V_{GS} = 10\text{V}, V_{DS} = 50\text{V}$ $R_L = 2.5\Omega, R_{GEN} = 6\Omega$		4.3		ns
Turn-On Rise Time	$t_r$			5.1		ns
Turn-Off DelayTime	$t_{D(off)}$			16.7		ns
Turn-Off Fall Time	$t_f$			8.7		ns
Body Diode Reverse Recovery Time	$t_{rr}$	$I_F = 15\text{A}, dI_F/dt = 100\text{A}/\mu\text{s}$		39		ns
Body Diode Reverse Recovery Charge	$Q_{rr}$	$I_F = 15\text{A}, dI_F/dt = 100\text{A}/\mu\text{s}$		30		nC

**Thermal Performance**

Parameter	Symbol	Typ.	Max.	Unit
Thermal Resistance, Junction-to-Ambient	$R_{\theta JA}$	54	65	$^\circ\text{C}/\text{W}$
Thermal Resistance, Junction-to-Case	$R_{\theta JC}$	1.7	2.1	$^\circ\text{C}/\text{W}$

**Notes:**

1. Computed continuous current assumes the condition of  $T_{j\_Max}$  while the actual continuous current depends on the thermal & electro-mechanical application board design.
2. This single-pulse measurement was taken under  $T_{j\_Max} = 175^\circ\text{C}$ .
3. This single-pulse measurement was taken under the following condition [ $L = 0.1\text{mH}, V_{GS} = 10\text{V}, V_{DS} = 50\text{V}$ ] while its value is limited by  $T_{j\_Max} = 175^\circ\text{C}$ .
4. The power dissipation  $P_D$  is based on  $T_{j\_Max} = 175^\circ\text{C}$ .
5. This value is guaranteed by design hence it is not included in the production test.

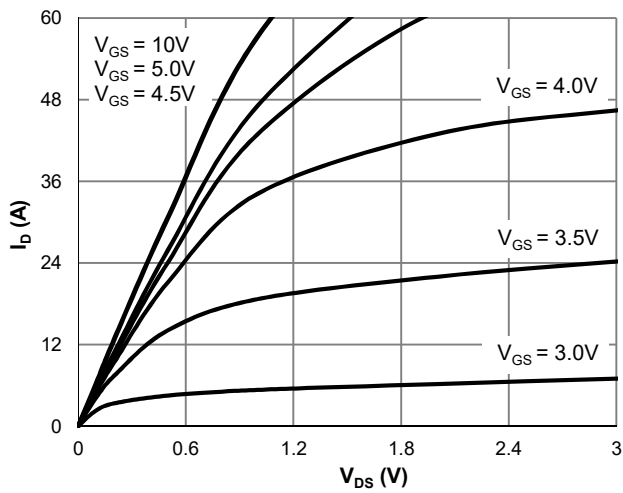
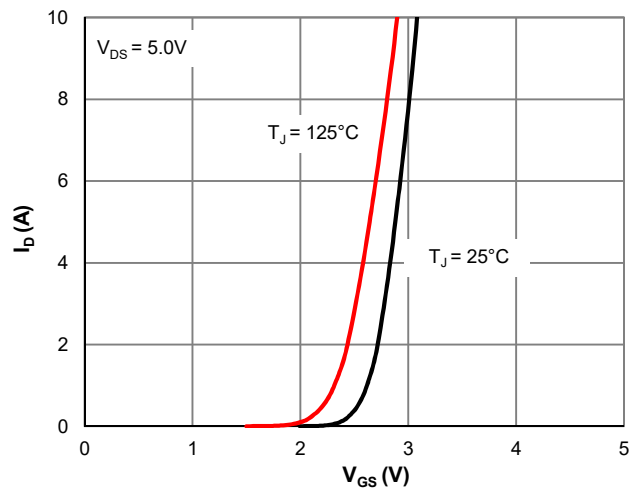
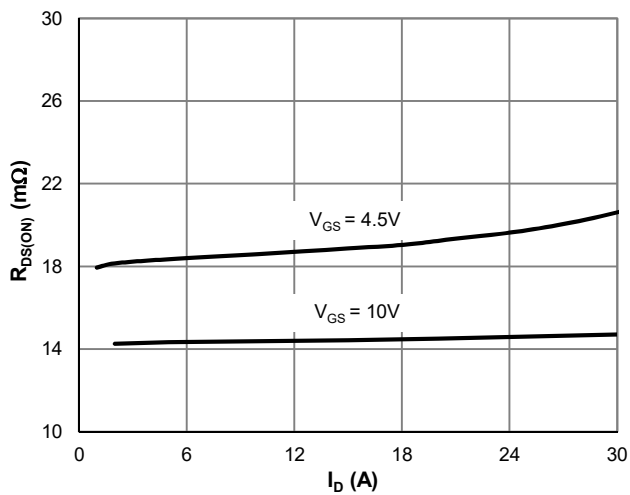
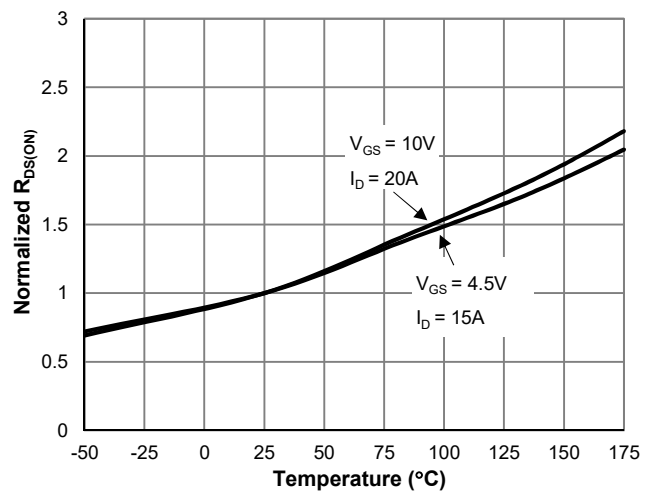
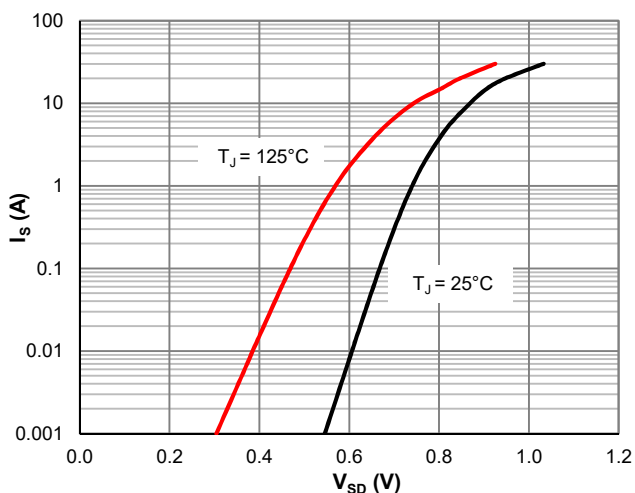
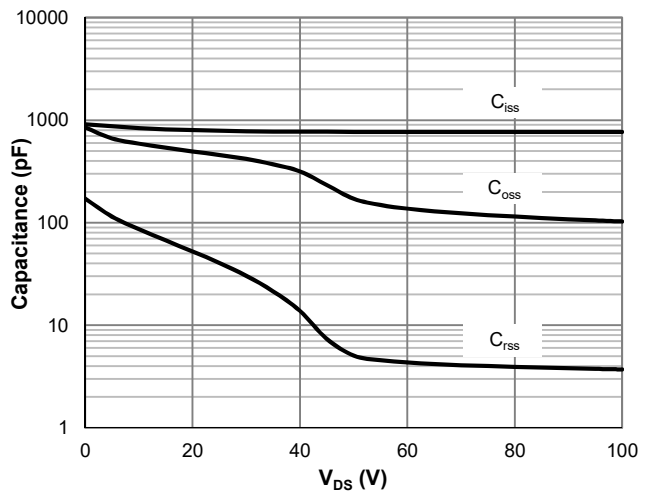
**Typical Electrical & Thermal Characteristics**

**Figure 1: Saturation Characteristics**

**Figure 2: Transfer Characteristics**

**Figure 3:  $R_{DS(ON)}$  vs. Drain Current**

**Figure 4:  $R_{DS(ON)}$  vs. Junction Temperature**

**Figure 5: Body-Diode Characteristics**

**Figure 6: Capacitance Characteristics**

Typical Electrical & Thermal Characteristics

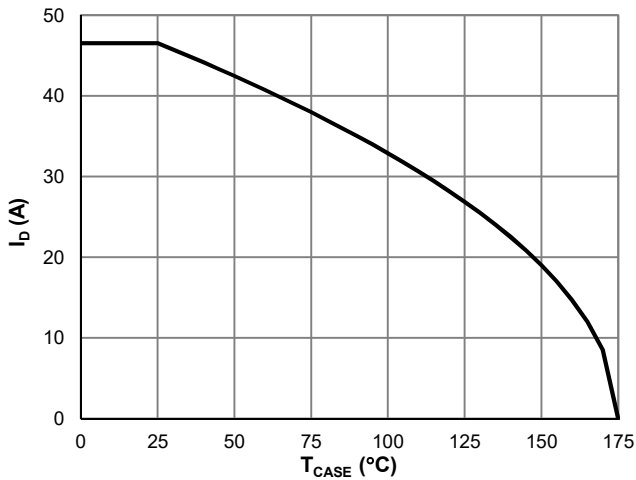

Figure 7: Current De-rating

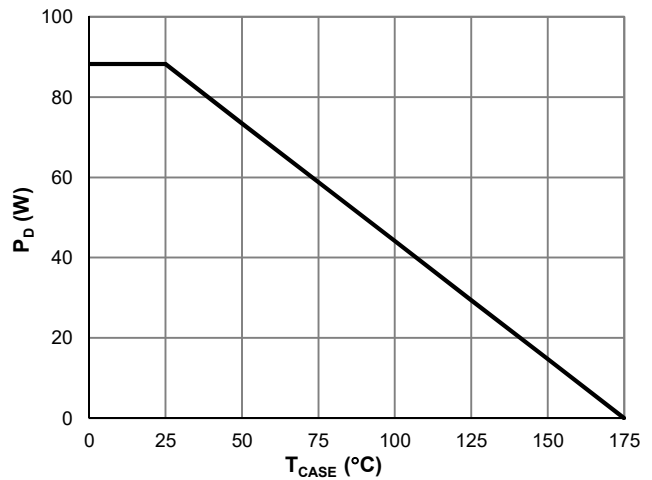

Figure 8: Power De-rating

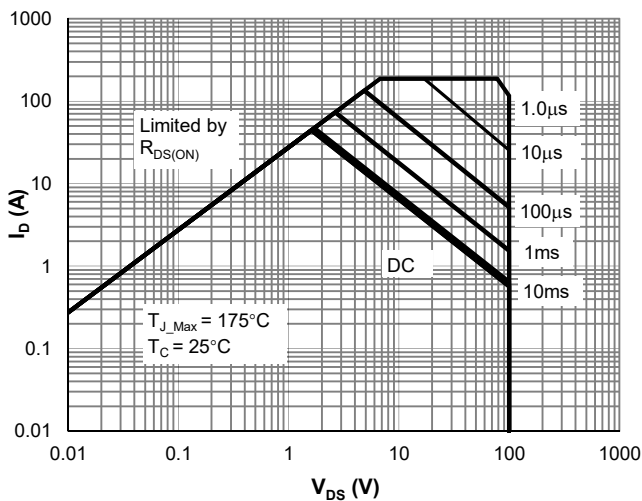

Figure 9: Maximum Safe Operating Area

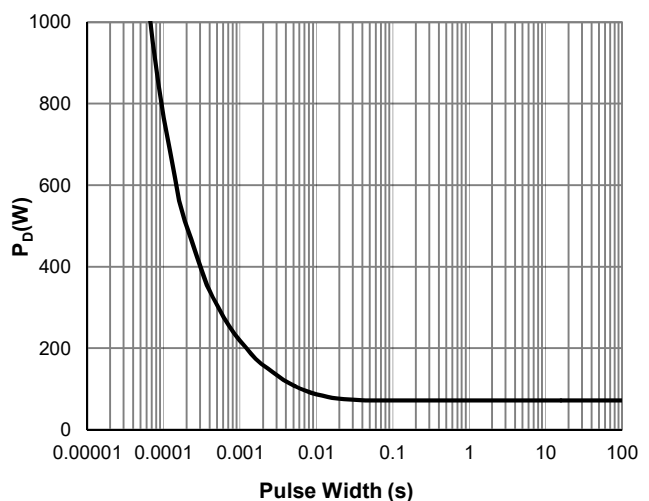

Figure 10: Single Pulse Power Rating, Junction-to-Case

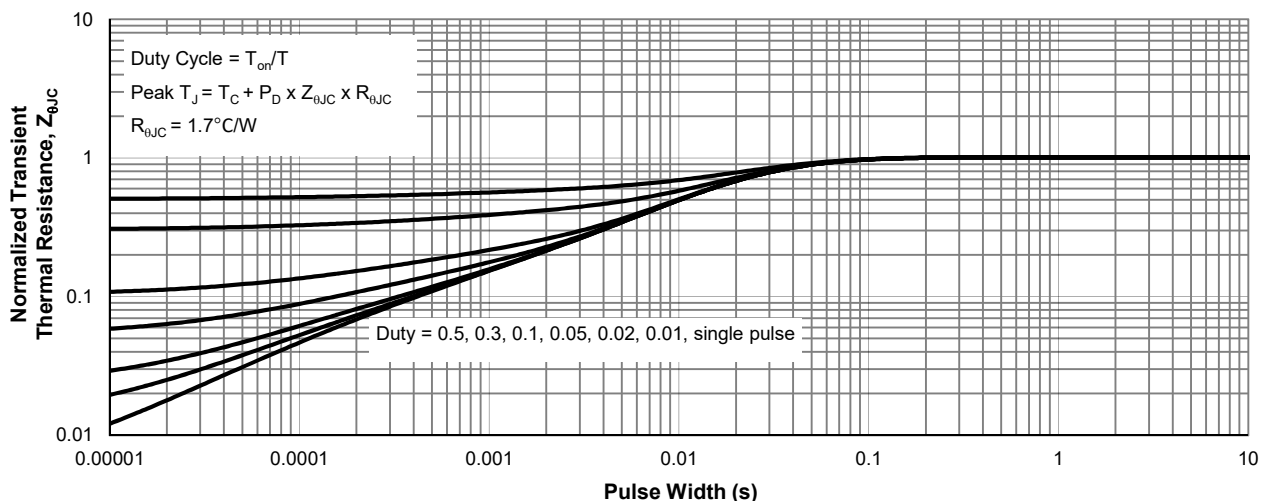
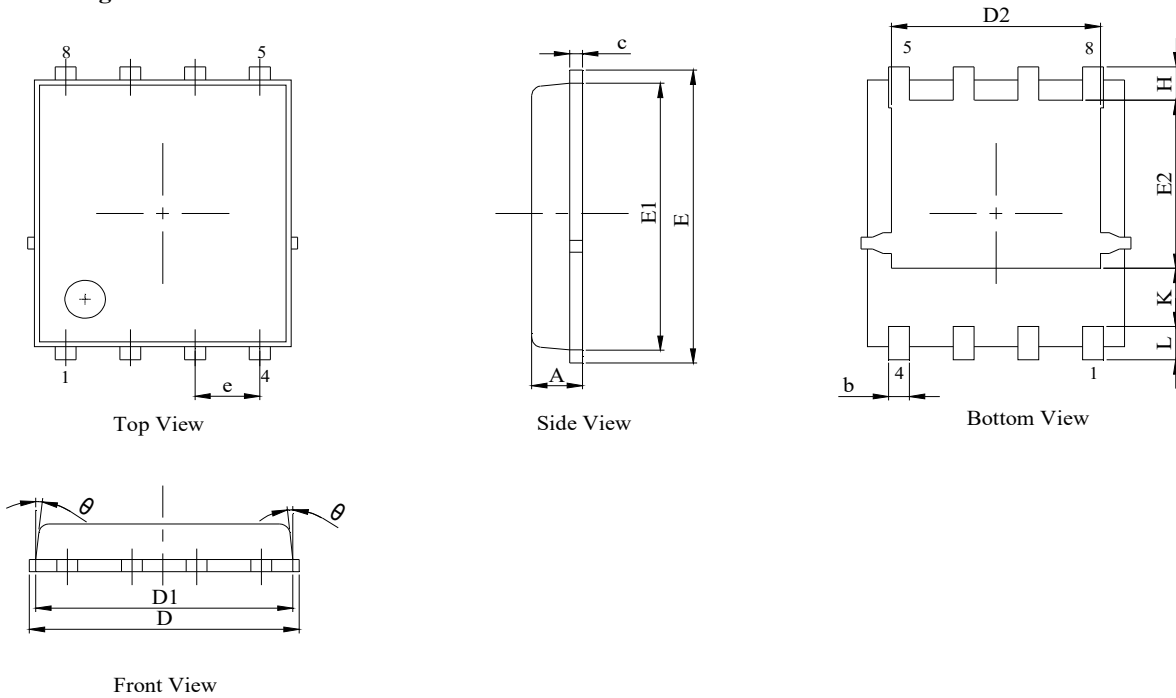
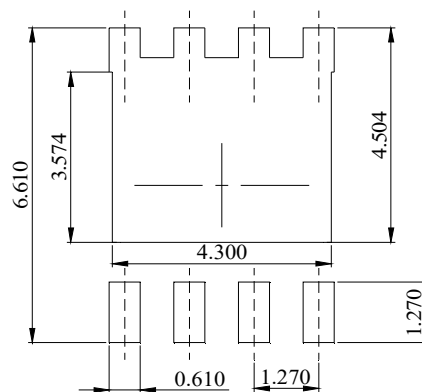

Figure 11: Normalized Maximum Transient Thermal Impedance

**PDFN5x6-8L Package Information**
**Package Outline**

**NOTES:**

1. Dimension and tolerance per ASME Y14.5M, 1994.
2. All dimensions in millimeter (angle in degree).
3. Dimensions D1 and E1 do not include mold flash protrusions or gate burrs.

DIM.	MILLIMETER		
	MIN.	NOM.	MAX.
A	0.90	1.00	1.10
b	0.31	0.41	0.51
c	0.20	0.25	0.30
D	5.00	5.20	5.40
D1	4.95	5.05	5.15
D2	4.00	4.10	4.20
E	6.05	6.15	6.25
E1	5.50	5.60	5.70
E2	3.42	3.53	3.63
e	1.27BSC		
H	0.60	0.70	0.80
L	0.50	0.70	0.80
$\theta$	-	-	10°

**Recommended Soldering Footprint**

DIMENSIONS: MILLIMETERS